

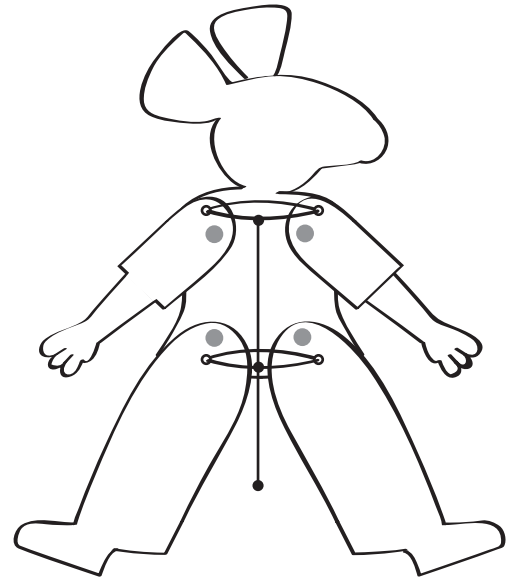

# Mądra Mysz



## Pajacyk część pierwsza

1. Wytnij z wydruku 1 i 2 części ciała myszy.
2. Naklej je na kawałek kartonu, pokoloruj i wytnij.
3. Teraz musisz połączyć wszystkie elementy za pomocą pinezek tak, jak na rysunku; następnie złóż je mocną nicią, tak, by przy pociągnięciu za nić mysz podnosiła ręce i nogi.



# Mądra Mysz

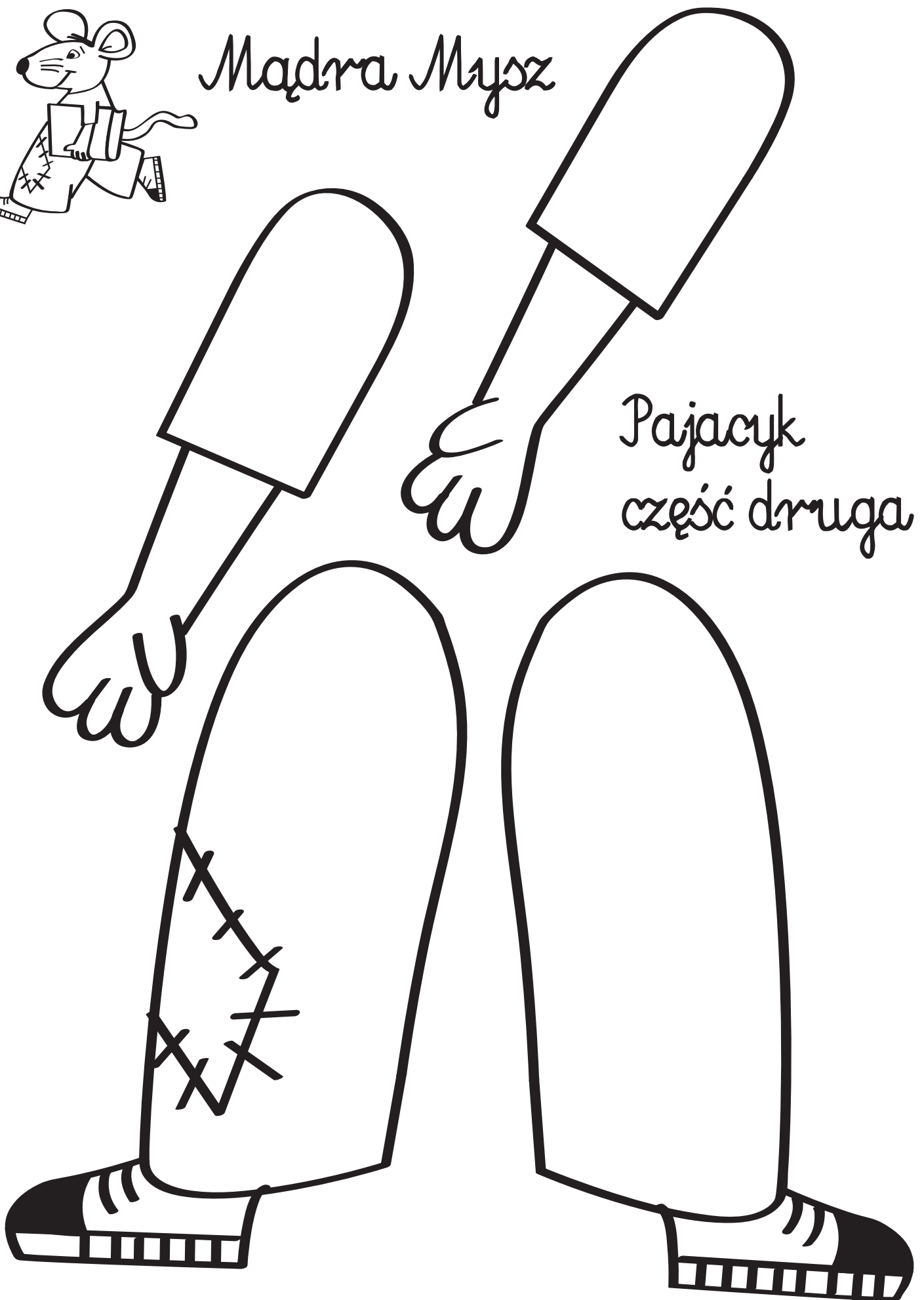

Pajacyk  
część druga



998



997

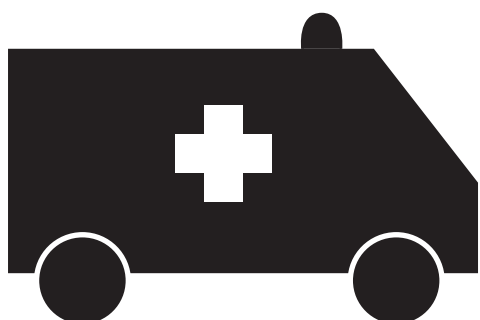

999

**TEREN BUDOWY  
WSTĘP  
WZBRONIONY**

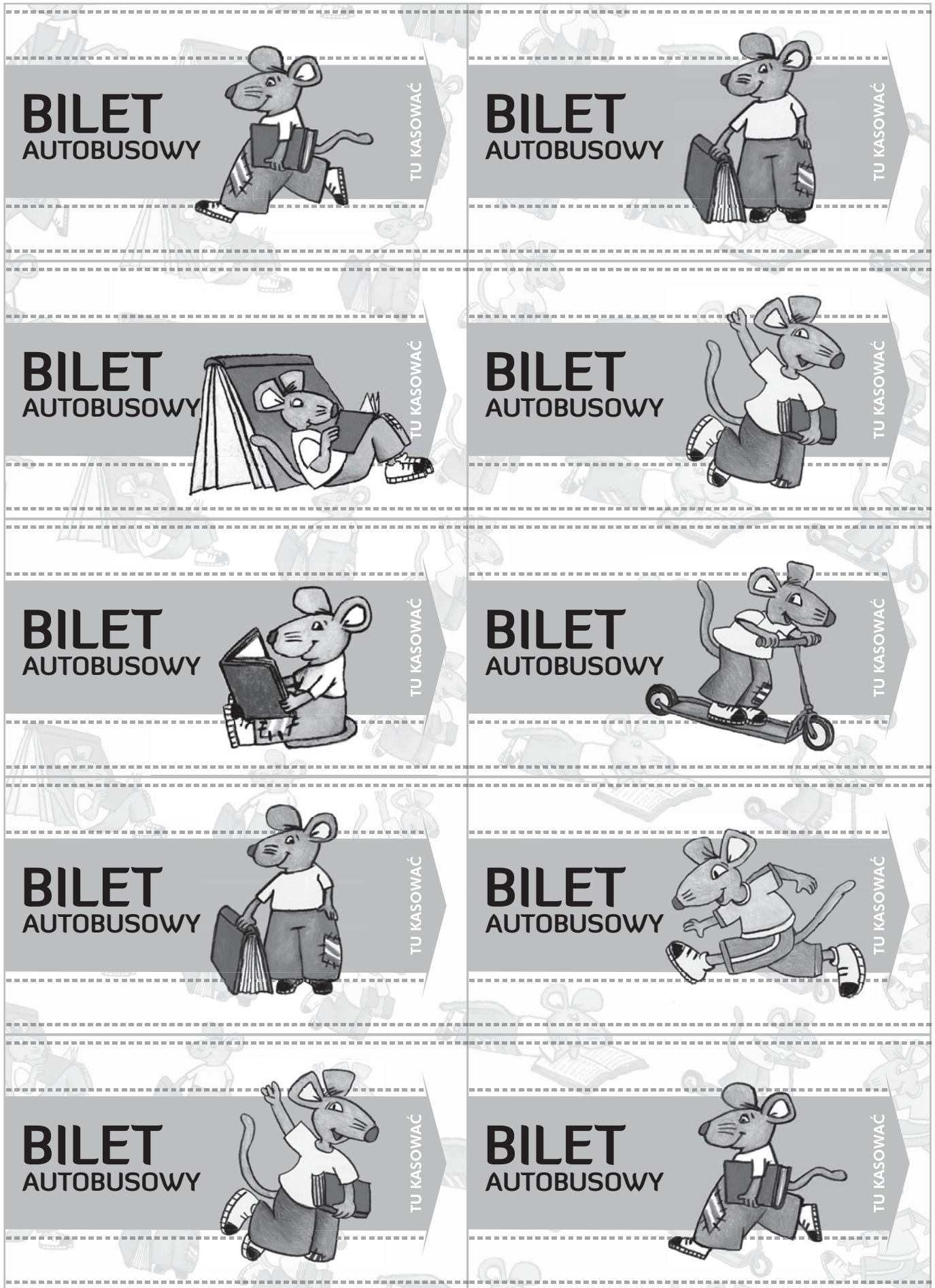



# Małdra Mysz i

tutaj wpisz swoje imię

## Pokoloruj swój dom

Przed Tobą obrazki kilku domów. Pokoloruj jeden z nich, ten, w którym chciałbyś mieszkać.

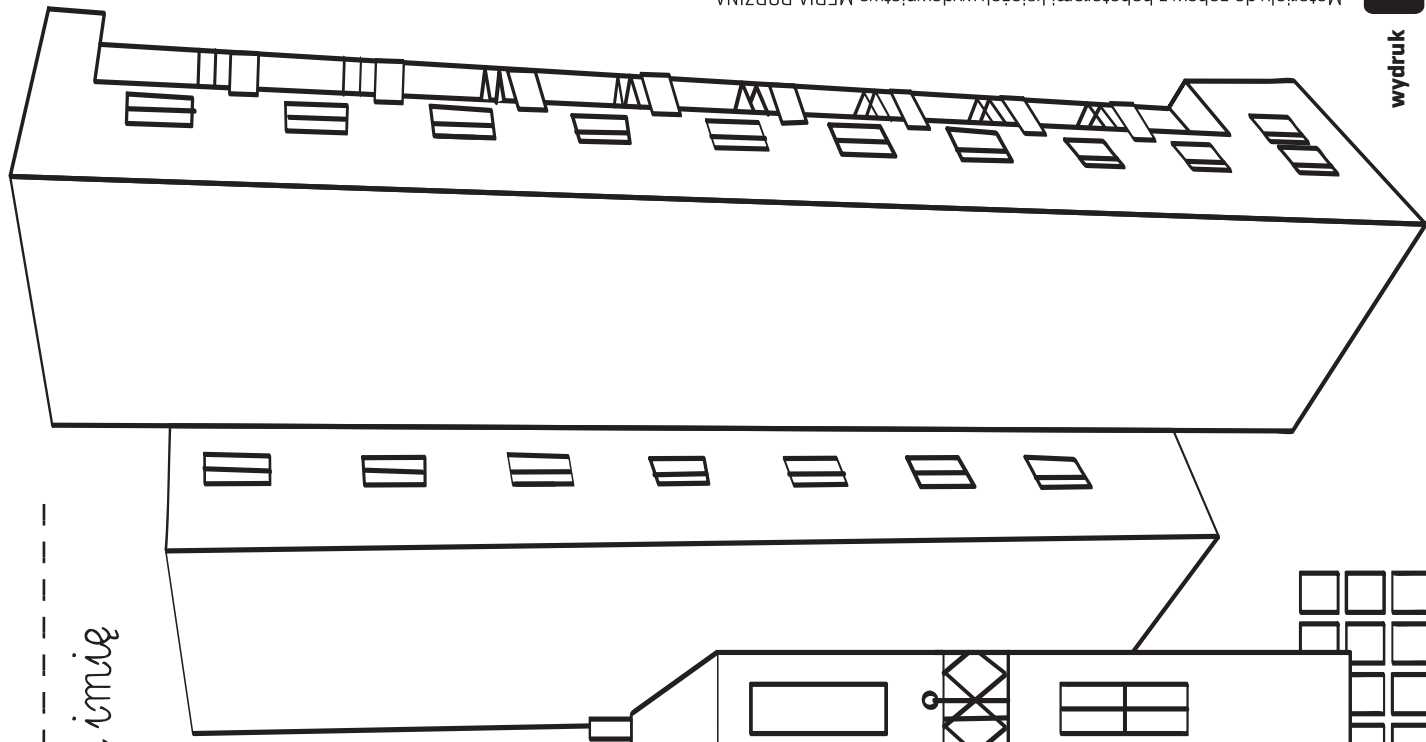
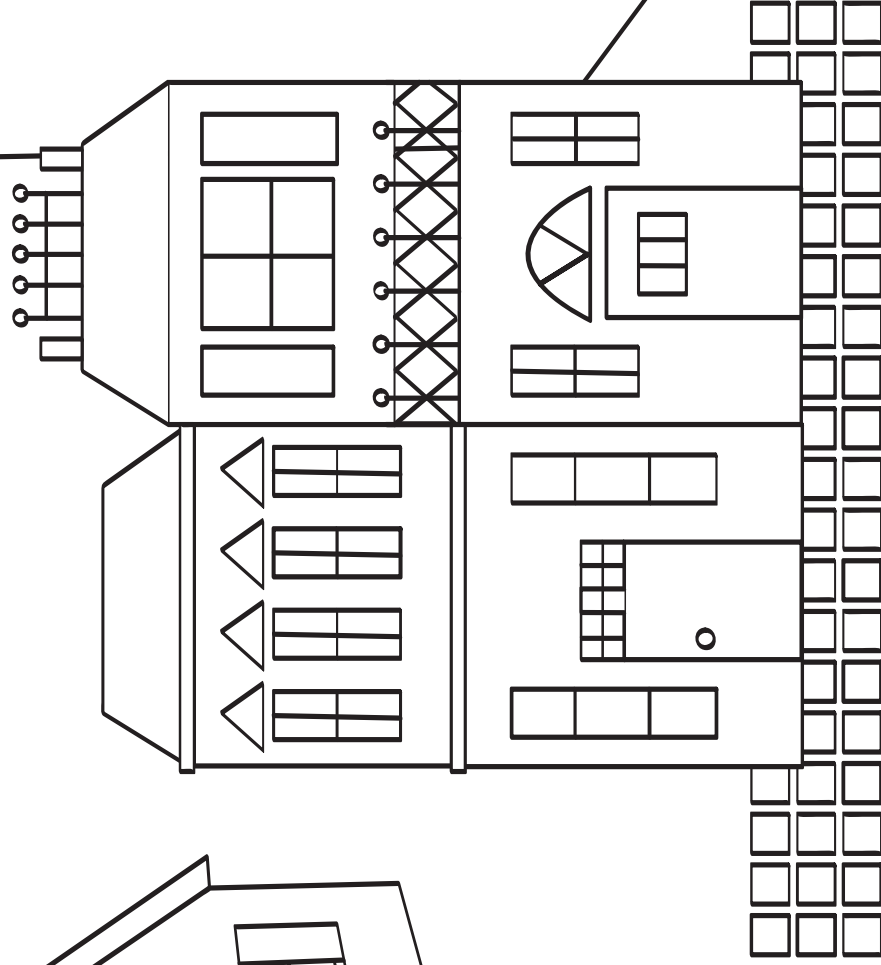
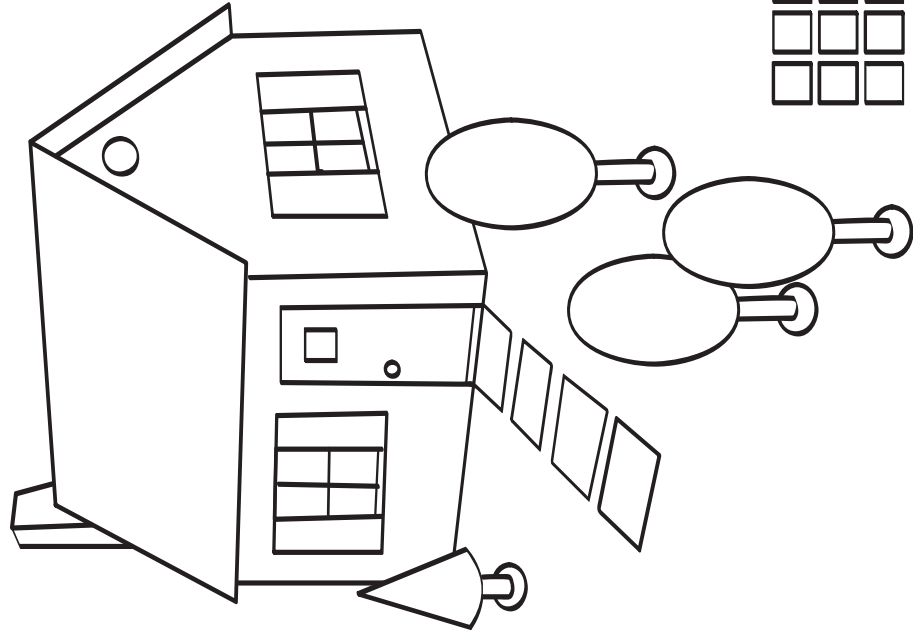

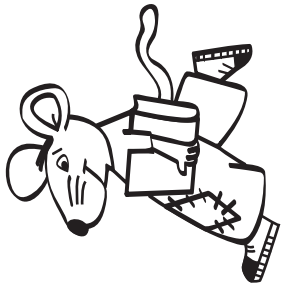

# Małdra Mysz i

tutaj wpisz swoje imię

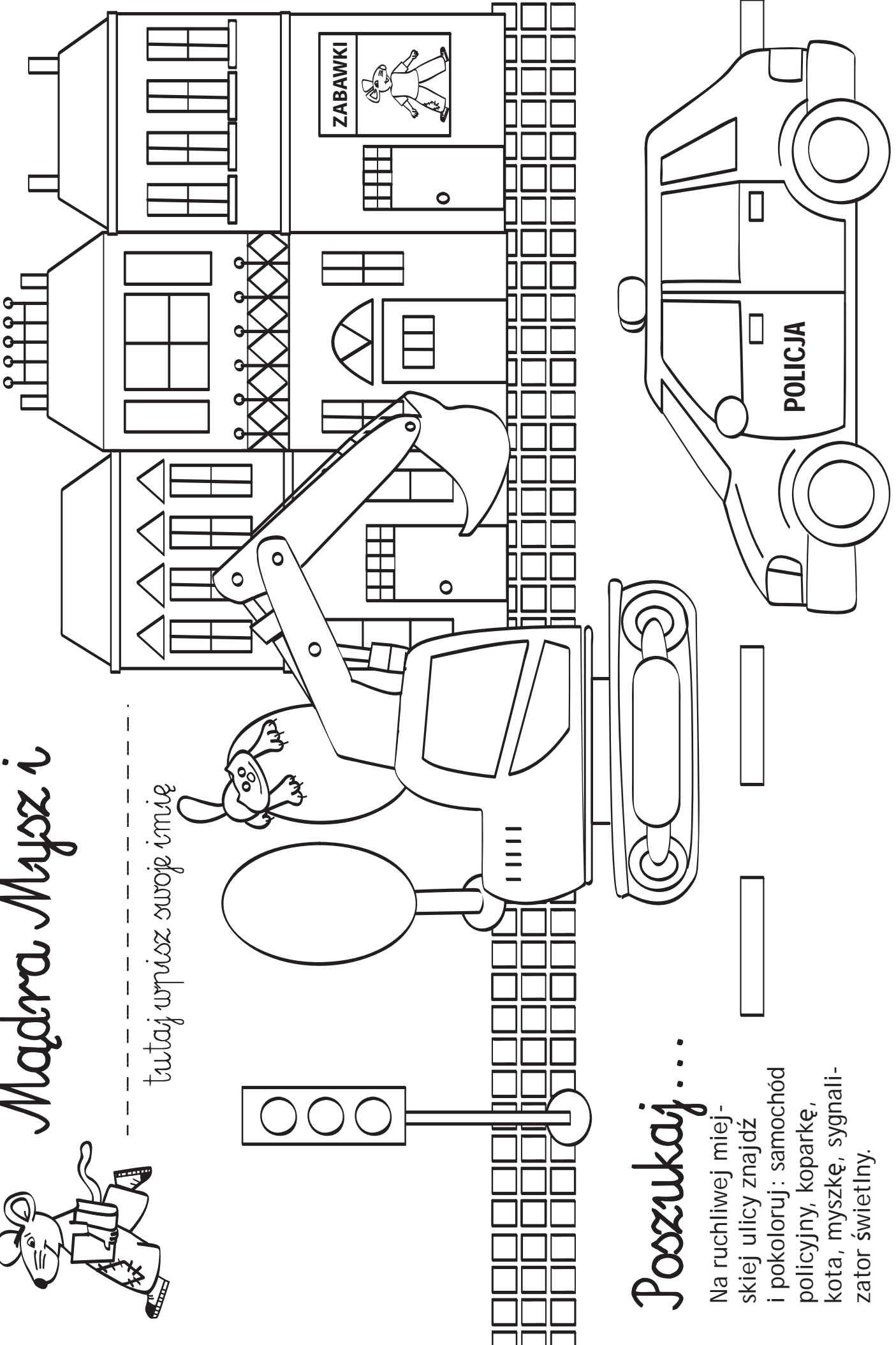

## Poszukaj...

Na ruchliwej miejskiej ulicy znajdź i pokoloruj: samochód policyjny, koparkę, kota, myszkę, sygnalizator świetlny.



# Mądra Mysz i

tutaj wpisz swoje imię



## Co tu nie pasuje?

Popatrz uważnie na rysunek i skreśl wszystko, co nie pasuje.

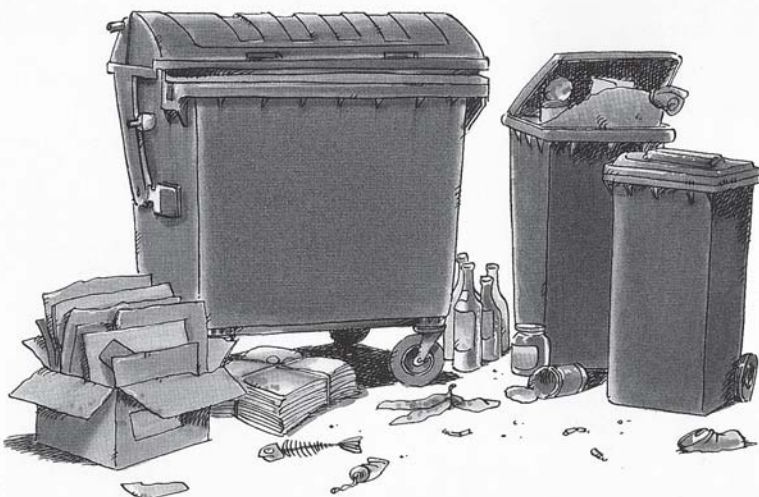

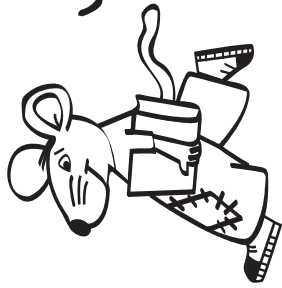

tutaj wpisz swoje imię

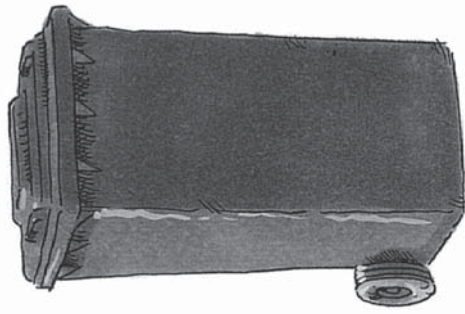
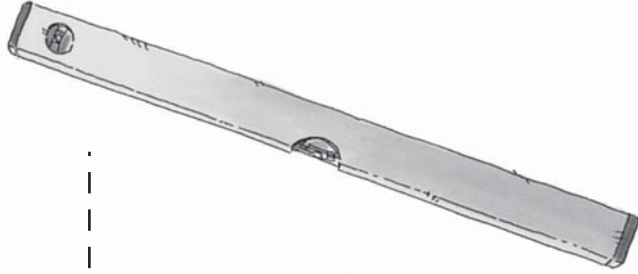
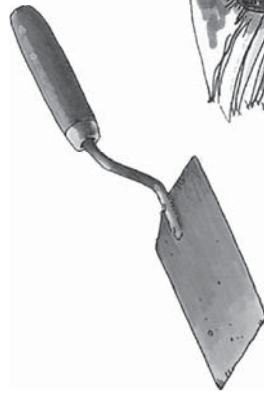
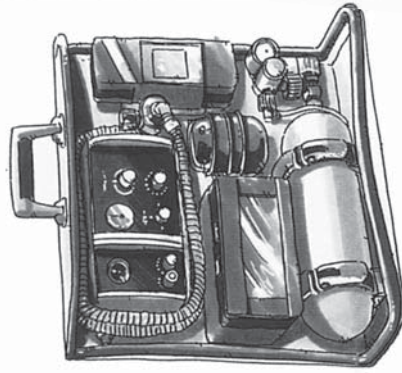

## Co do kogo należy?

U dołu kartki kartki stoja strazak, budowniczy, policjant i smieciaz. U gory znalazlo sie mnogo ruznych przedmiotow. Potacz linia osoby i przedmioty, ktore sa im potrzebne w ich pracy.

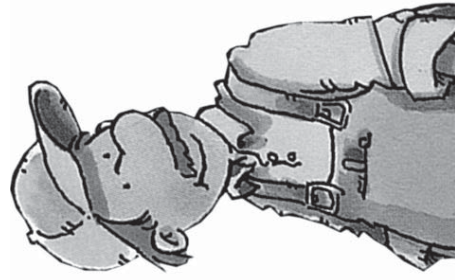
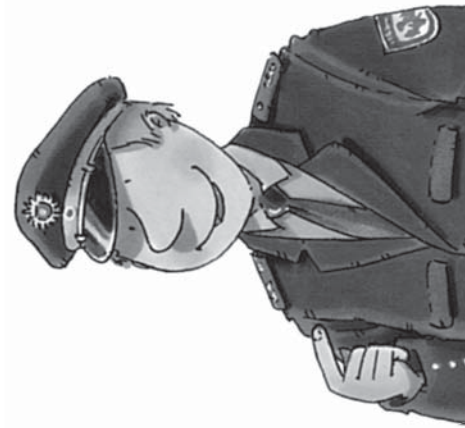
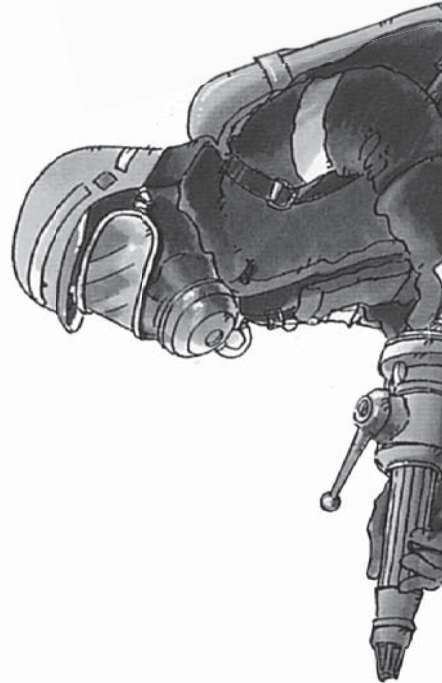



# Małdra Mysz i

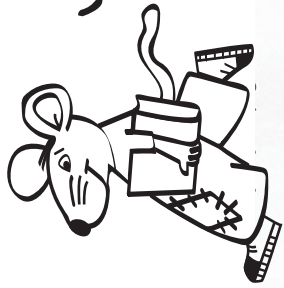

tutaj wpisz swoje imię

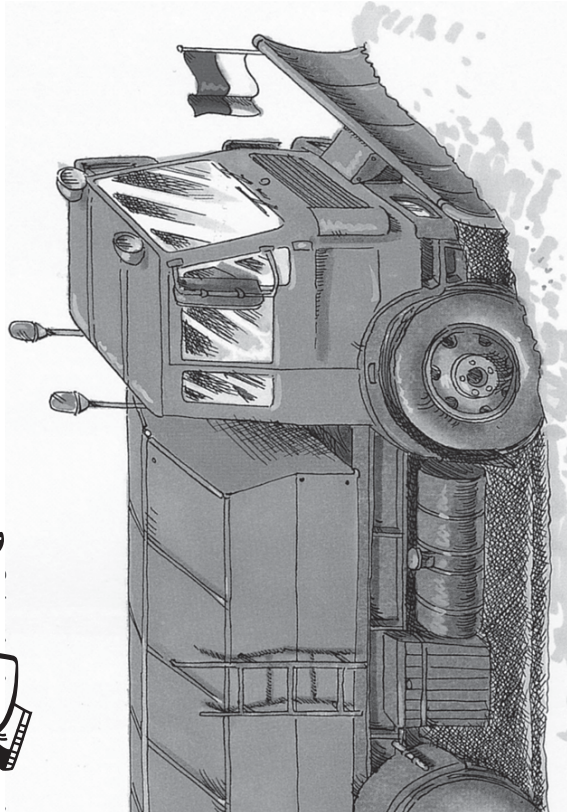

## Pojazdy

Dopasuj pojazdy do przedstawionych na obrazku osób.





# Mądra Mysz

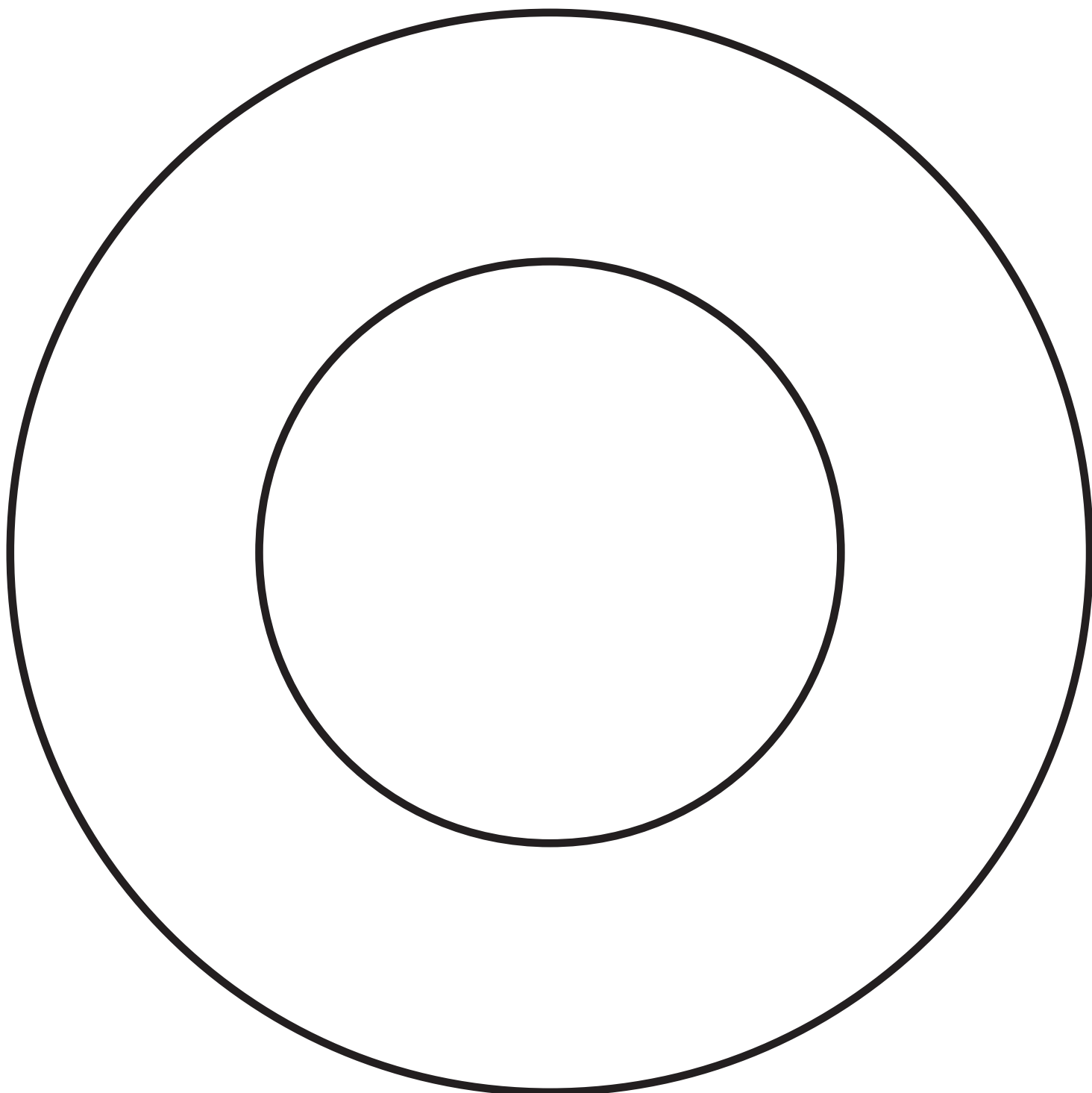

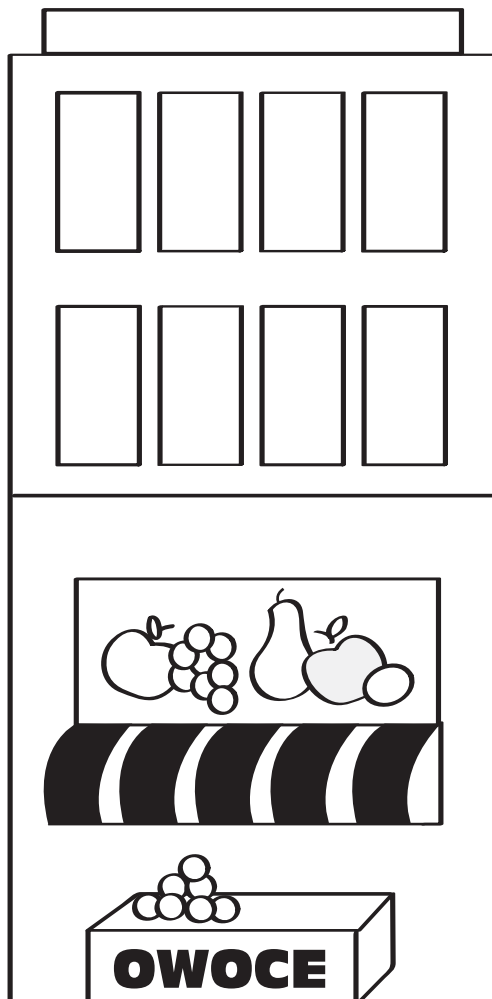
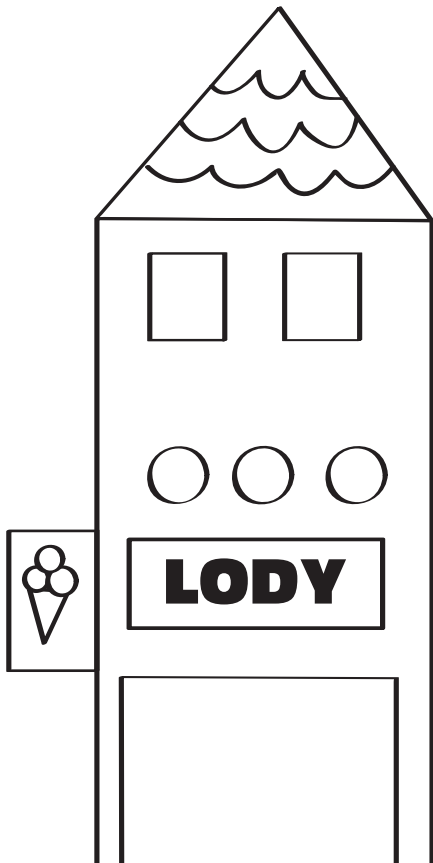
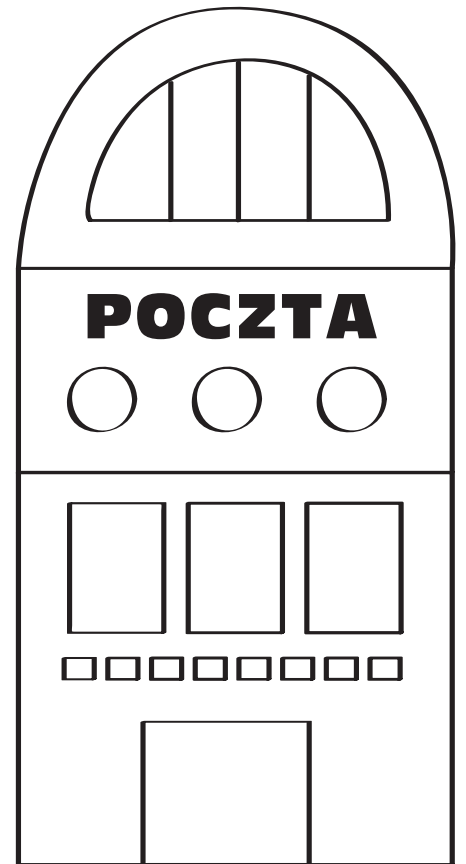
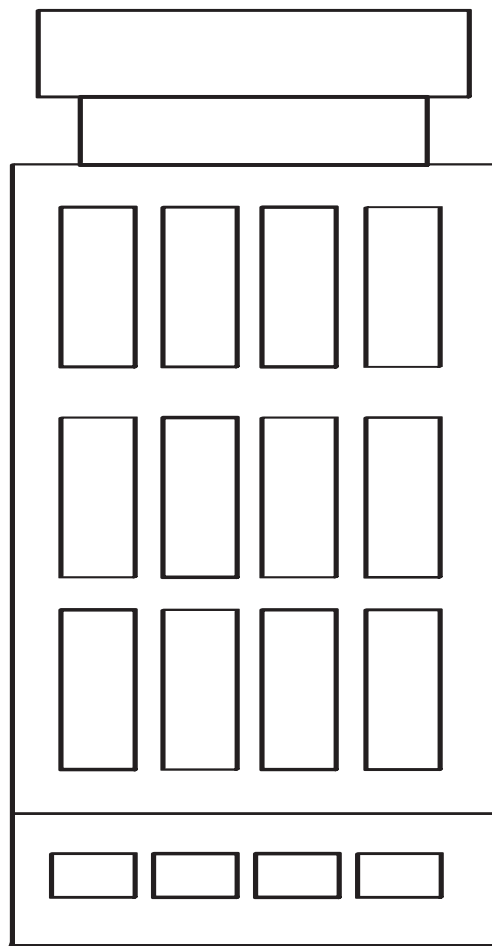
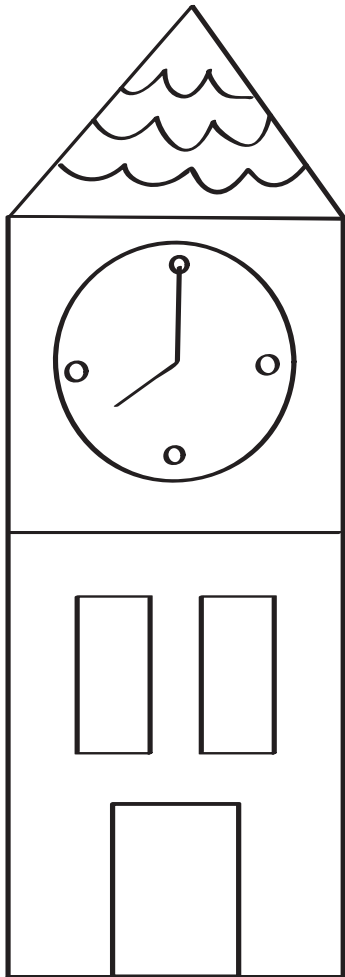

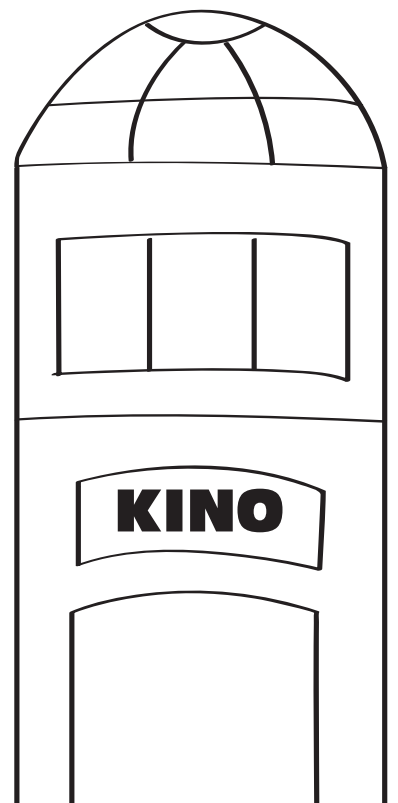
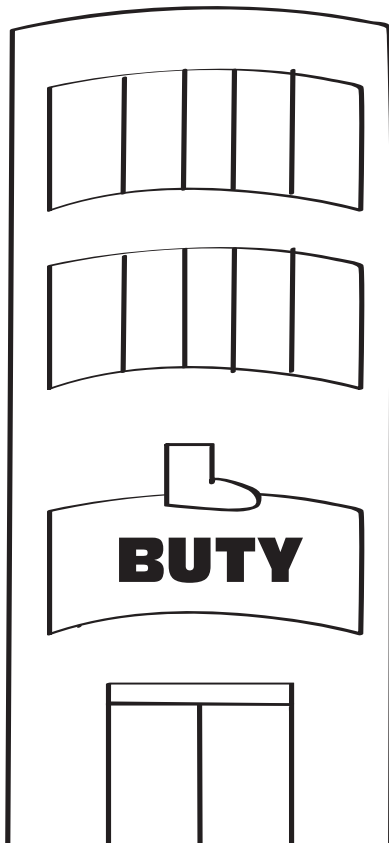
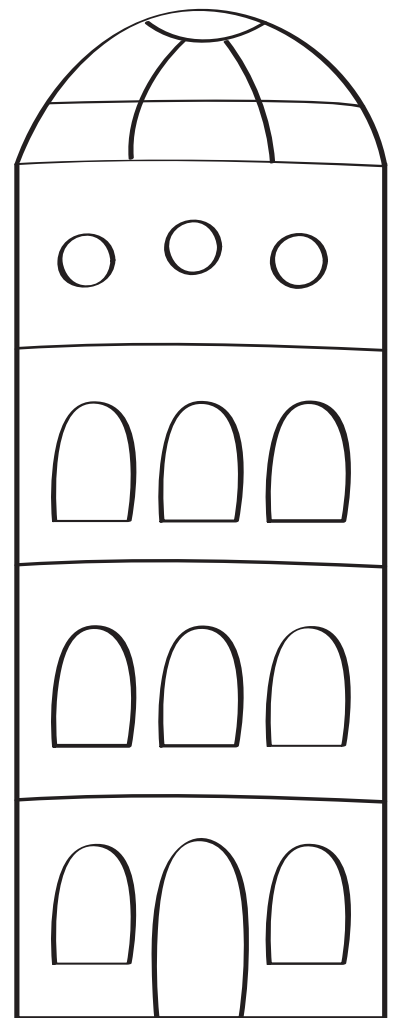
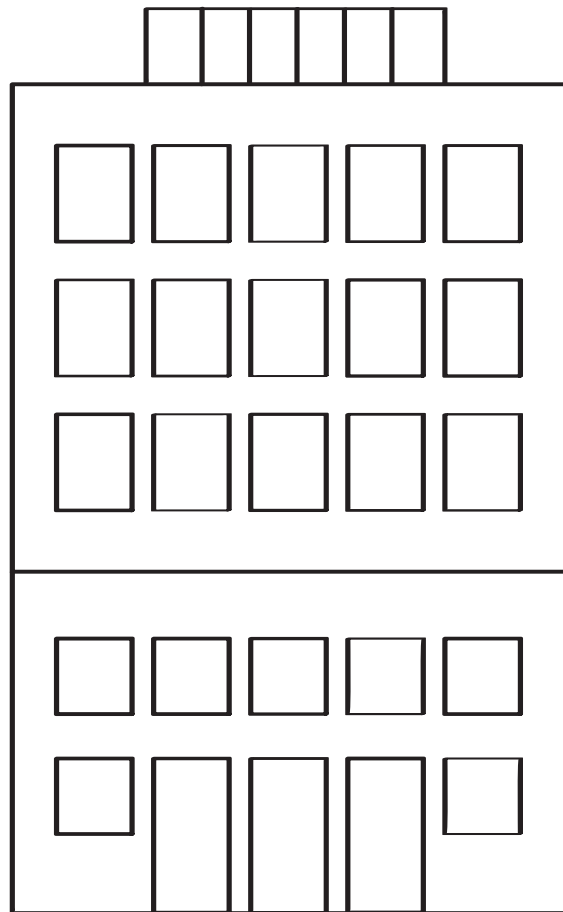
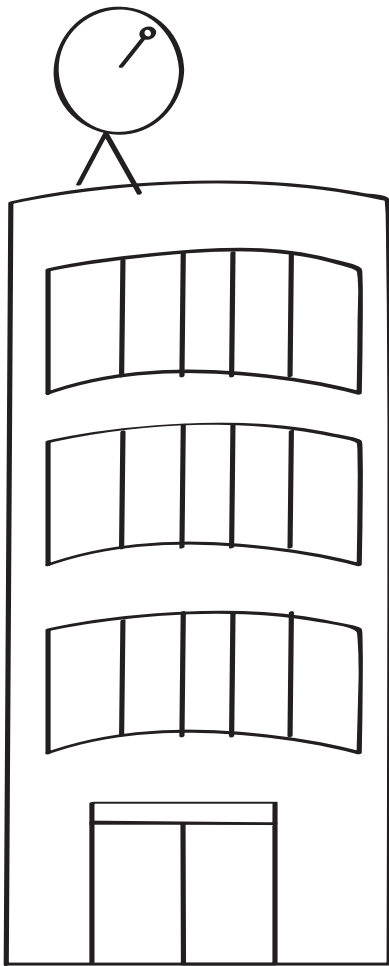

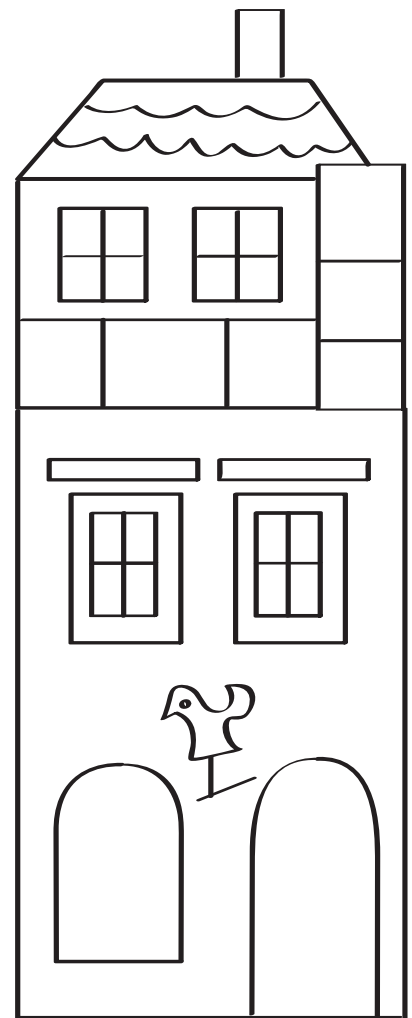
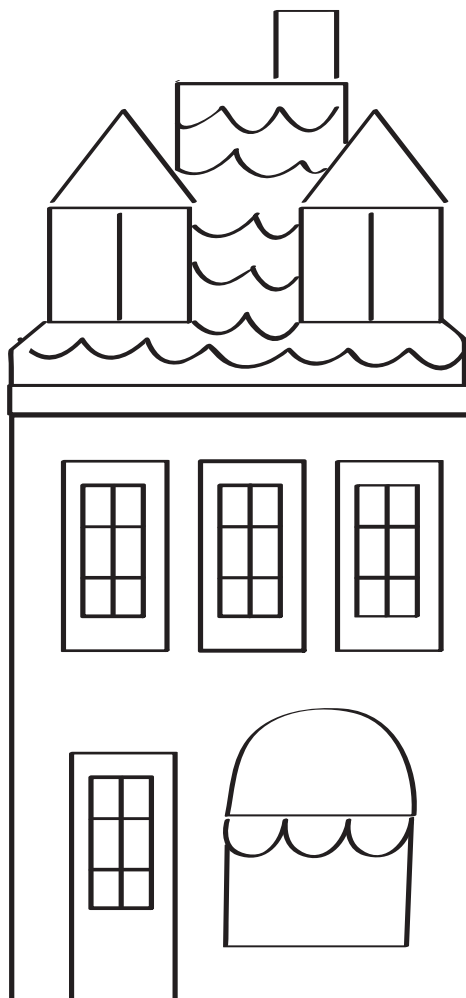
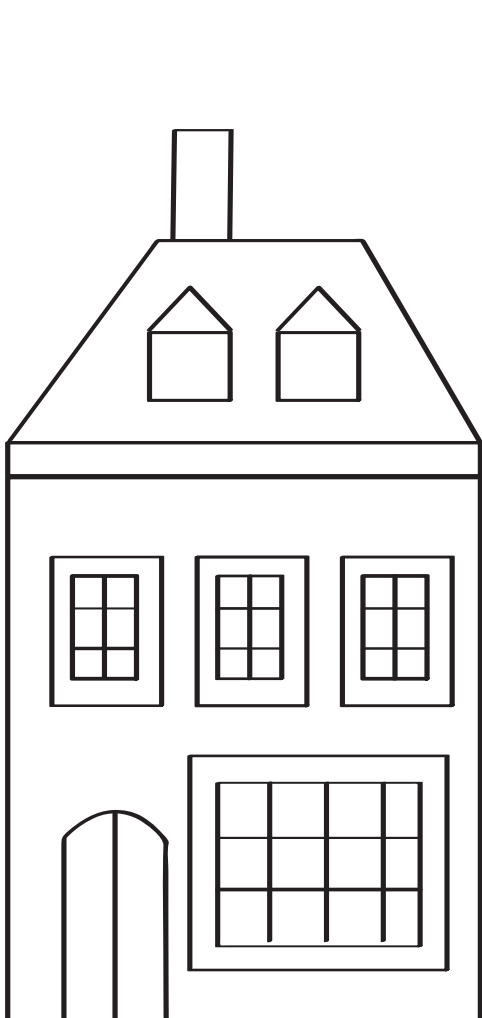
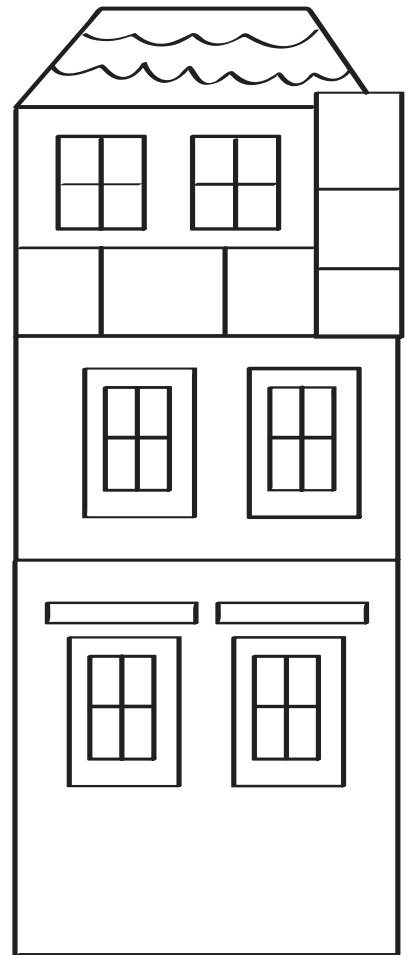
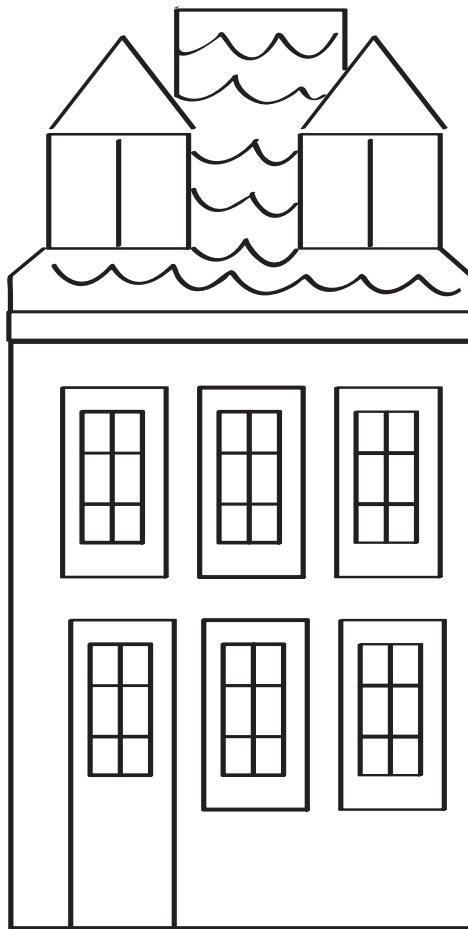
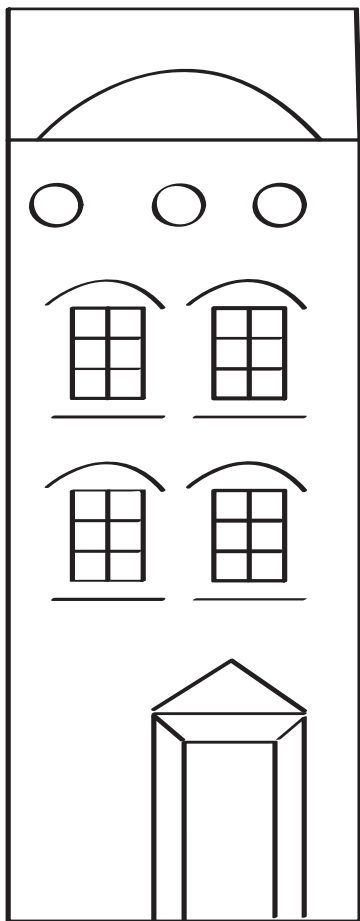

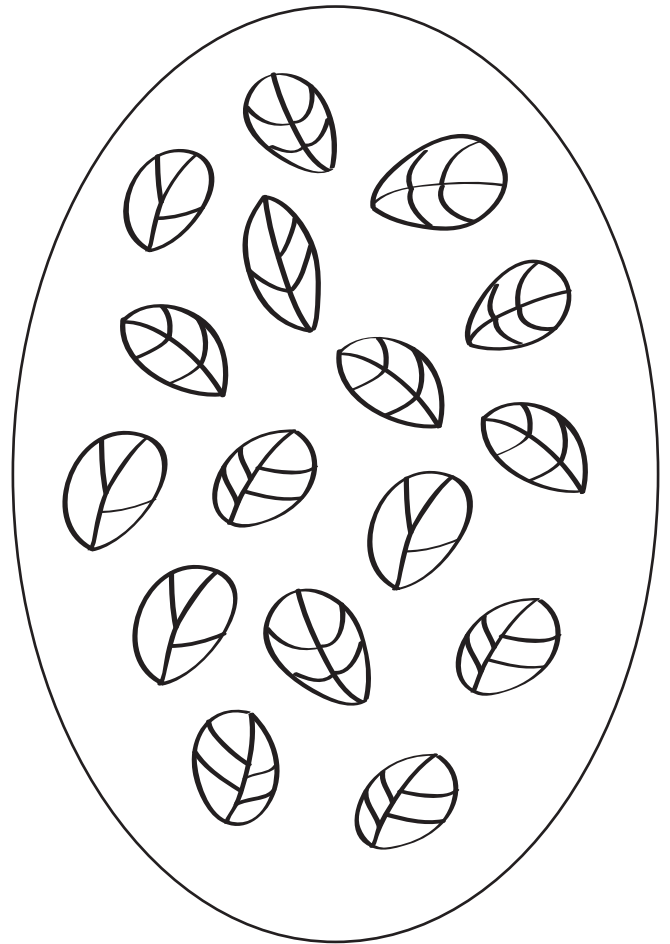
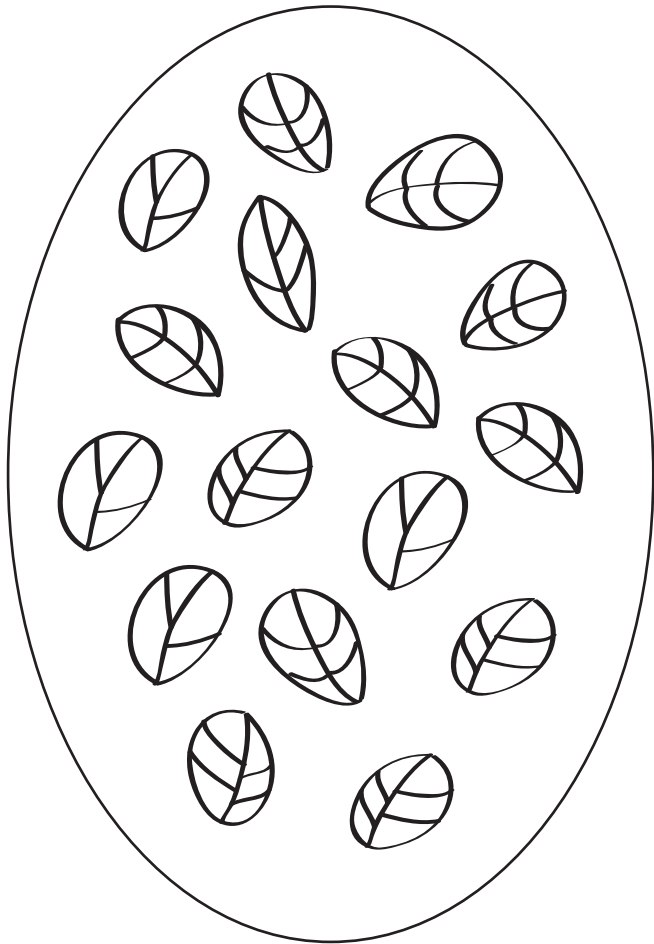
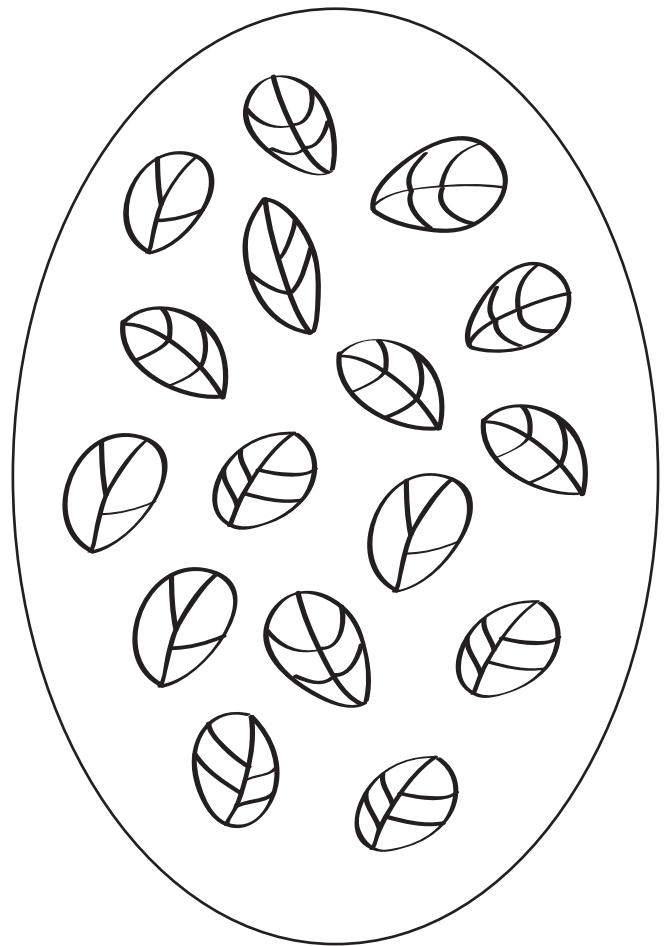
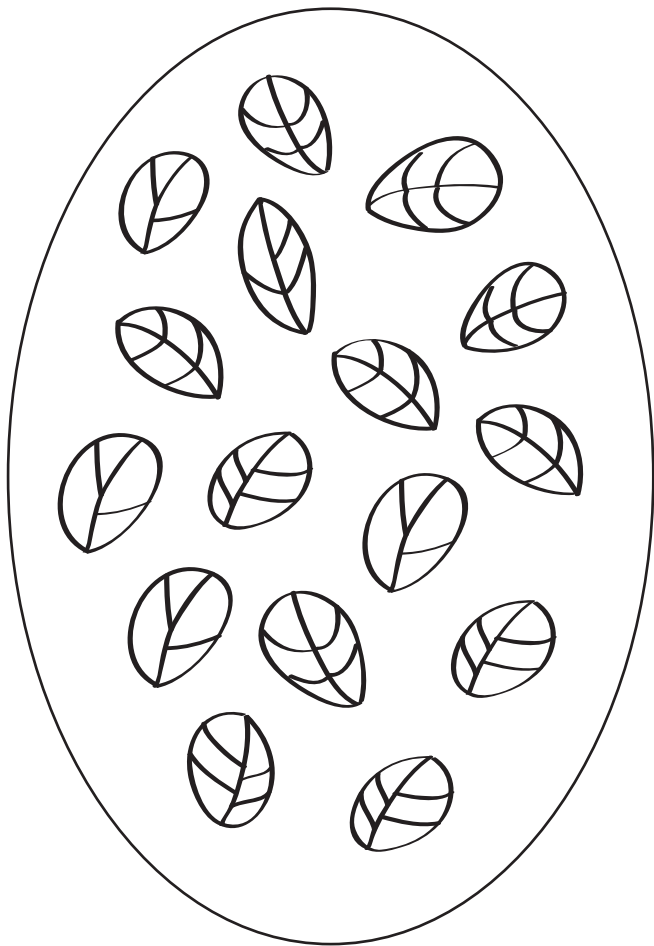

# EKOZNAKI



**dbaj o czystość**



**recykling**



**opakowania z aluminium  
nadające się do recyklingu**



**opakowania z tworzyw  
sztucznych nadających się  
do recyklingu**



**sprzęt elektryczny lub elek-  
troniczny podlegający zbiór-  
ce w wyznaczonych punktach**

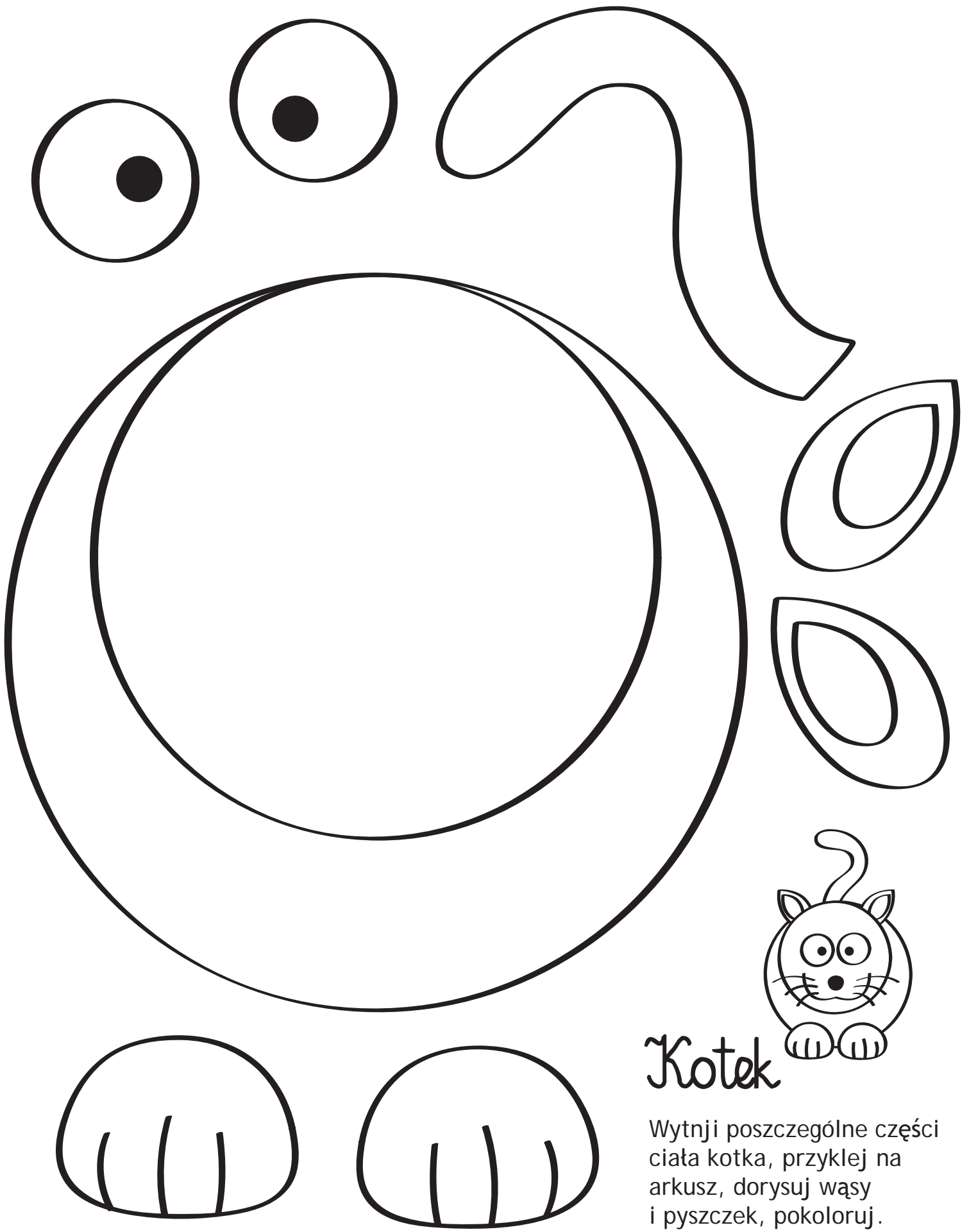

# Kotek

Wytnij poszczególne części ciała kotka, przyklej na arkusz, dorysuj wąsy i pyszczek, pokoloruj.



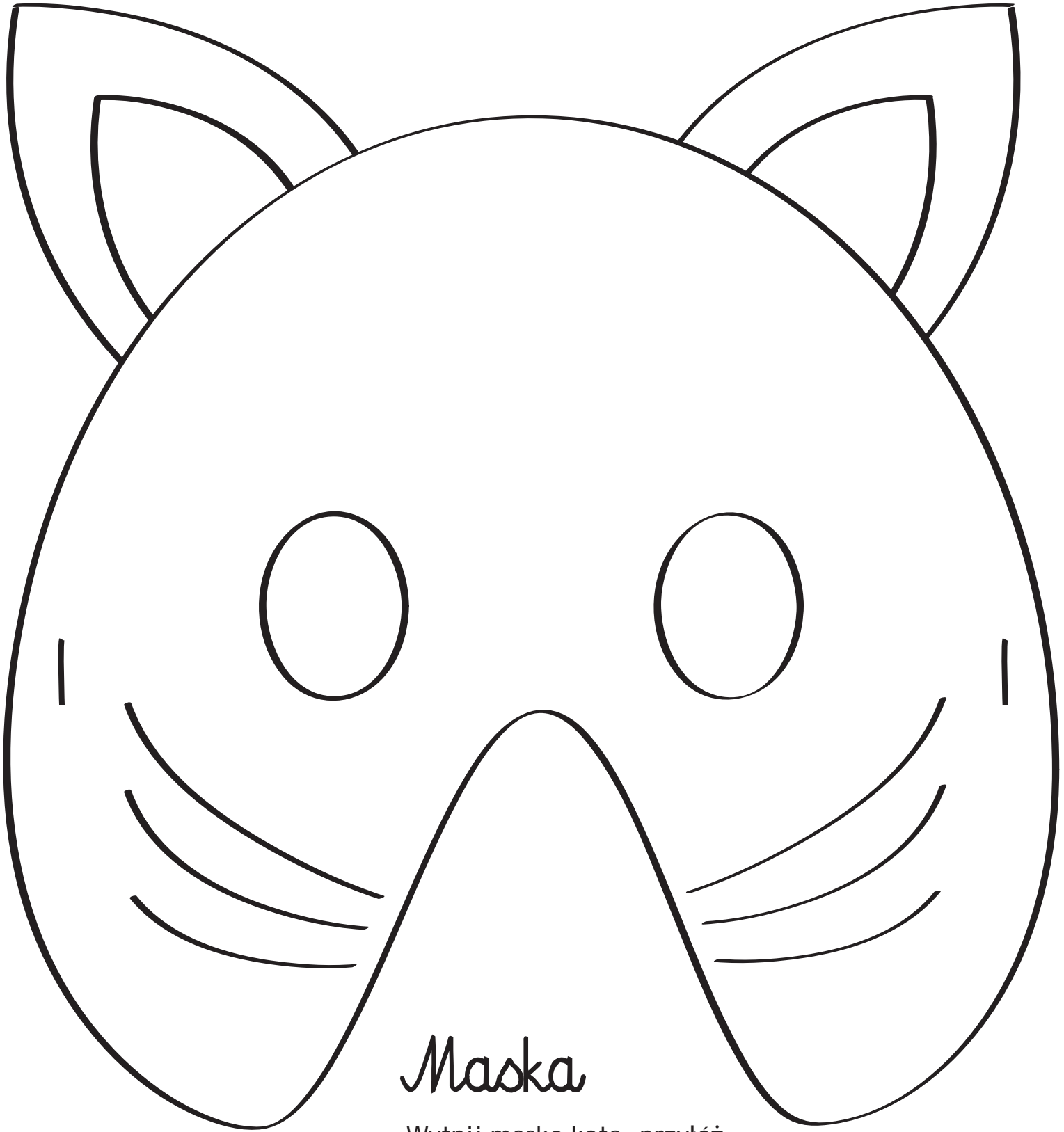

## Maska

Wytnij maskę kota, przyłóż na arkusz A4, obrysuj białą kredką lub ołówkiem, wytnij jeszcze raz. Pokoloruj kredkami (kotki zazwyczaj są pasiate!)

# Ogłoszenie

Zgubił się kotek taki, jak na obrazku.  
Proszę pomóc w odnalezieniu.

Zuzia



# Mądra Mysz i

tutaj wpisz swoje imię



Gdzie jest kotek?

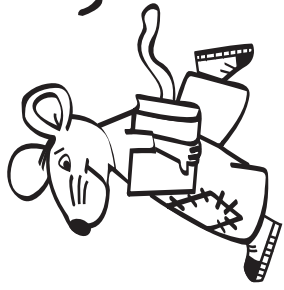

# Madra Mysz i

tutaj wpisz swoje imię

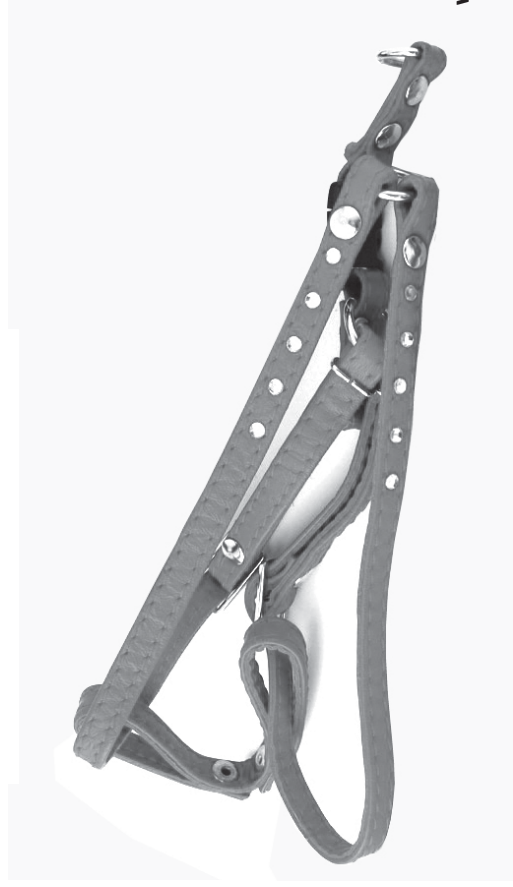
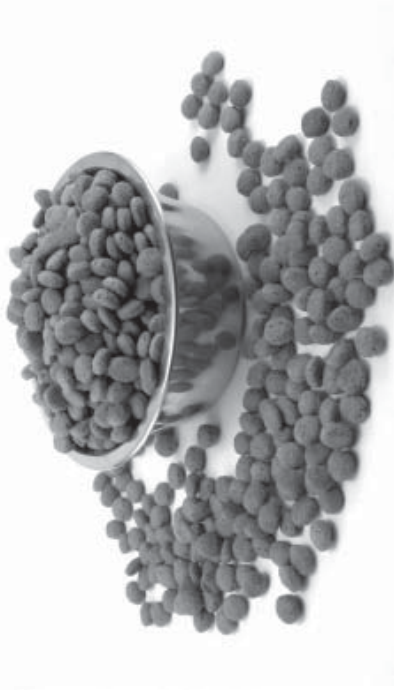
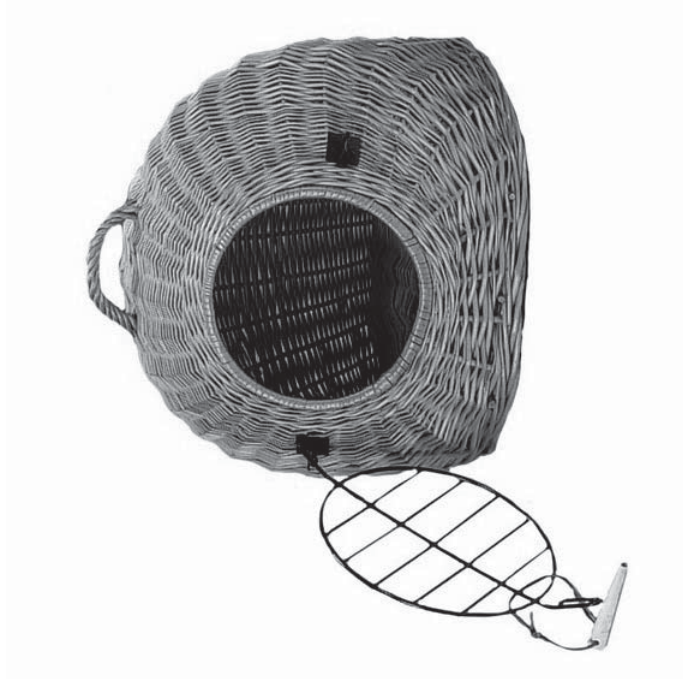

## Pielęgnacja kotka

Na tym obrazku jest dużo różnych przedmiotów. Oprowadź czerwoną kredką te, które są potrzebne do pielęgnacji kotka.